



FLEXSTONE
LUXURIOUS BATH SURROUNDS

2-Panel Shower Kit Install Instructions

For missing items do not return to store.

Please call 877-941-3662

(Monday – Friday 8:00 a.m. – 5:00 p.m MT)

2-wall Shower Surround Instructions

Splendor Series

Neo-Angle/Neo-Round Models: FLX40407821

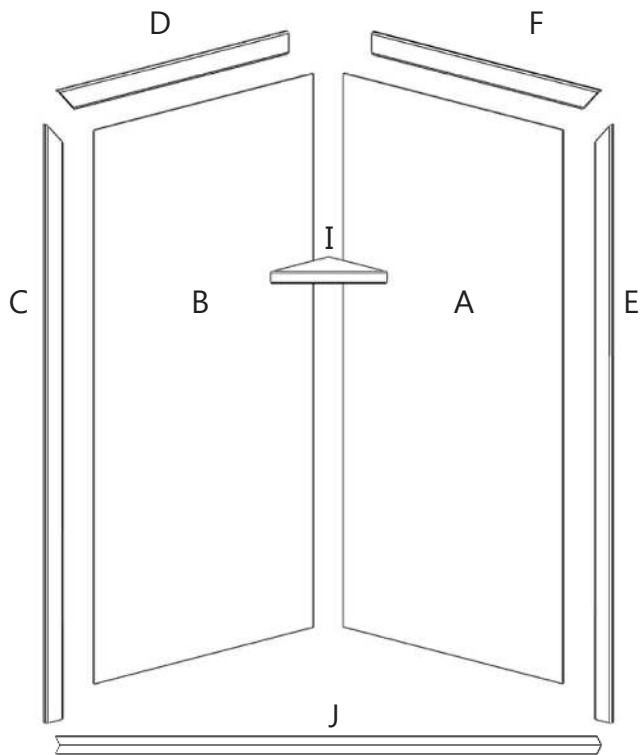

Elegance Series

Rectangular 2-wall Models: FLX48367821

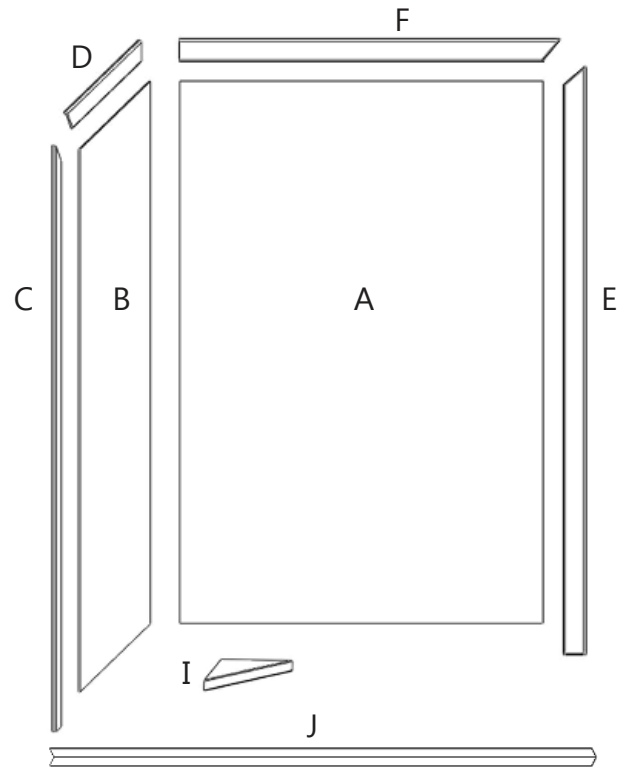

| Item | Description | Qty |
|------|-------------------------------|-----|
| A | Back wall panel | 1 |
| B | Side wall panel | 1 |
| C | Left wall front mitered trim | 1 |
| D | Left wall top mitered trim | 1 |
| E | Right wall front mitered trim | 1 |
| F | Right wall top mitered trim | 1 |
| I | Corner shelf with bracket | 1 |
| J | Inside corner reinforcement | 1 |

| Item | Description | Qty |
|------|-------------------------------|-----|
| A | Back wall panel | 1 |
| B | Side wall panel | 1 |
| C | Left wall front mitered trim | 1 |
| D | Left wall top mitered trim | 1 |
| E | Right wall front mitered trim | 1 |
| F | Right wall top mitered trim | 1 |
| I | Corner shelf with bracket | 1 |
| J | Inside corner reinforcement | 1 |

Please inspect packages for damage or missing pieces, and read instructions carefully prior to installation. All FlexStone products come with a protective masking covering the image side of the material. If you have any questions or issues, please call our customer support **Monday – Friday 8:00 a.m. – 5:00 p.m. MT at 877-941-3662.**



Visit <http://FlexstoneProducts.com/installation> to access a walk-through video and other useful installation information.

Required Tools

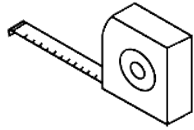

Tape Measure

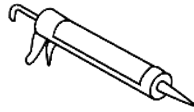

Caulk Gun



Clamp

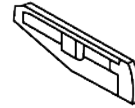

Utility Knife

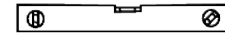

Level

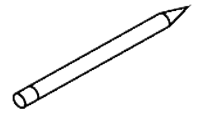

Pencil

Helpful Tools

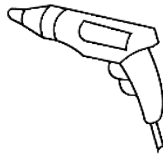

Drill

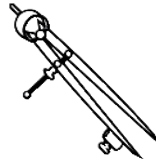

Compass

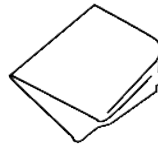

Clean Cloth

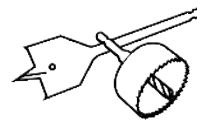

Paddle Bits
or Hole Saws

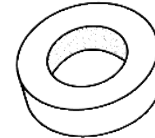

Painter's Tape



Denatured
Alcohol

Installation Kit

Your shower surround kit includes eight cartridges of adhesive and two cartridges of color-tinted 100% silicone. Refer to section 2B of these instructions for adhesive usage guidelines.

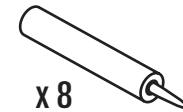

x 8

Construction
Adhesive

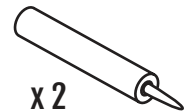

x 2

100% Silicone

Before Starting



Consult your local building codes with questions on installation compliance standards. Building and plumbing codes may vary by location, and FlexStone Bath Systems is not responsible for code compliance standards for your project.

1. The FlexStone wall system is designed to be installed over a solid substrate such as green board, cement board, or other water resistant backers. Substrate should be clean, dry, and free of dust or loose paint. Unless using our Remodel Trim Kit, any existing surround material should be removed.
2. The Remodel Trim Kit (sold separately) allows FlexStone to be used over existing tile. Tile should be in good shape, and wall surfaces should be flat (i.e. remove any accessories that would interfere with the FlexStone panels.) The 4 pieces of 96" length would replace Items C, D, E, F, and G. Follow instructions included with Remodel Trim Kit.
3. If installing a new bathtub or shower base prior to FlexStone installation, follow the manufacturer's instructions, and install the tub or base level and square to walls.
4. Turn off the water supply and complete any plumbing modifications prior to installing your FlexStone surround. Leave plumbing handles off until surround is installed. Plan the placement of the shower head such that it is either above the height of the wall panels or at least 2" below the top of the wall panels. This will keep the trim moldings from interfering with the pipe and escutcheon plate.
5. Review Section 6 and decide how the vertical trim moldings will be installed, either outside the shower base, or on top of the base threshold. This will impact the width of the side wall panels in Section 3.

Install Instructions

1. Installation of Inside Corner Reinforcement (J)

A. Flashing Tape Corner Reinforcements go behind the panels in the back vertical corners for added leak protection. This tape has been cut to length, matching the height of the panels of your kit.

B. Apply a bead of adhesive onto both walls about 3/4 inch away from the corner. Fold the flashing tape at the center crease with the print side together, then press the tape into the corner using a taping or putty type blade. Using the same blade, flatten out the tape to create a flat, smooth inside corner. Wipe away any excess adhesive.

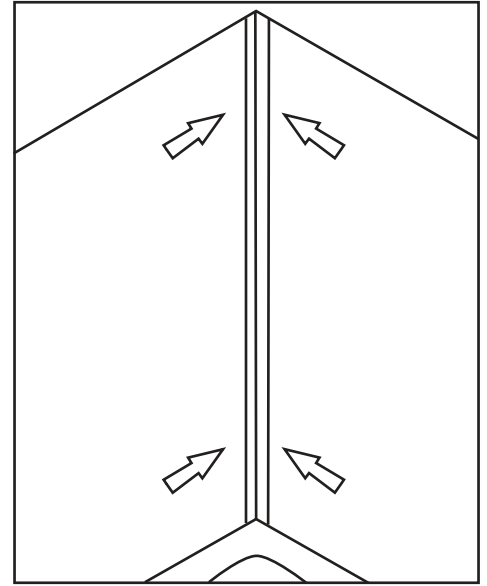

2. Installation of Back Wall Panel (A)

NOTE: It is not necessary to cut the top edges of panels to be level, as they will be covered by trim moldings. For right-hand plumbing wall installs, reverse Panels A and B in these instructions.

A. Each wall panel should be fit to the back corner, and to the shower base. This may usually be done by trimming either the vertical corner edge, or the edge that rests on the base. In some circumstances you will need to trim both to achieve a tight fit. Dry fit the panel by trimming with a utility knife, jigsaw, or power plane.

B. When satisfied with the fit, peel protective masking back from the edges of the panel (approx. 4") and clean burrs from any rough edges. Apply adhesive in lines or dollops to the back of the panel in a pattern every 4 to 6 inches. Use approximately one 10oz tube per 12 square feet following the adhesive directions on the tube. Push the panel in place, lightly pounding to achieve good bond.

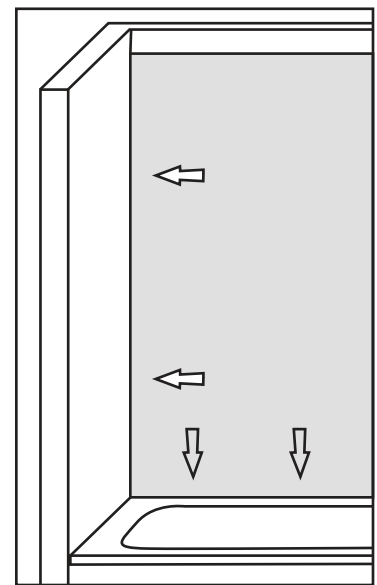

3. Installation of Wet/Plumbing Wall Panel (B)

A. Hold side panel as close to plumbing wall as possible. Scribe and trim the inside edge and bottom edge against the shower base for best fit before measuring, marking, and cutting holes for plumbing fixtures. The depth of the side wall panels can also be trimmed down to fit the opening or your shower base, although how you decide to install vertical trims C and E will influence the width sizing of side wall panels (see Section 4.)

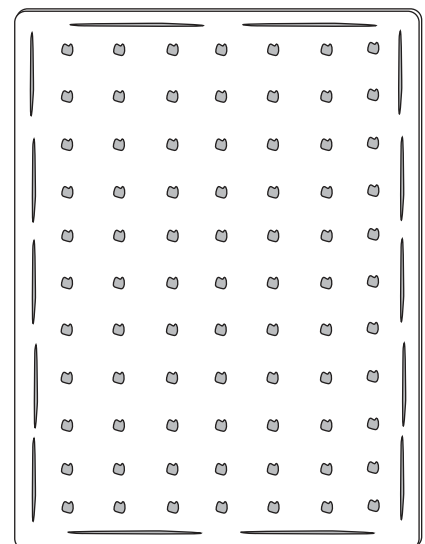

NOTE: It is not necessary to cut the top edges of panels to be level, as they will be covered by trim moldings. For right-hand plumbing wall installs, reverse Panels A and B in these instructions.

B. For each hole to be cut, measure the vertical distance between the center of the plumbing fixture and the shower base. Measure the horizontal distance between the center of the fixture and the installed back wall panel. Mark the center of the fixtures on the face of the panel.

C. Using a drill, make a small pilot hole in marked locations. Using a jigsaw, hole saw, or paddle bit cut out each hole in the panel to the appropriate size for the particular pipe or fixture. Make each hole only as large as necessary for access to the plumbing. Cover plates only cover so much!

D. With holes drilled so the panel now fits over the plumbing, you can fine tune the fit of the panel into the back corner and against the shower base from step 3.A.

E. Prior to adhering the plumbing wall panel, seal the back panel A to the corner reinforcement using a small bead of Performance Pro 100% Silicone.

F. Follow Step 2.B and adhere the side panel, but also form a bead of adhesive on the back around each plumbing hole.

4. Installation of Side Wall Trims (C,D,E,F)

NOTE: Trim moldings are shaped like an "L", and the long leg is designed to overlap panels, with the short leg returning back to the sheetrock and hiding the panel edge. Be sure to peel protective masking back from the edges of the panels before adhering the trim moldings.

NOTE: Vertical trim moldings are designed to be installed either: 1) resting on top of the shower base threshold, or 2) outside the threshold and running down to the floor. Depending on the size of your opening, you may even choose to contour cut the trim moldings to overlap the threshold partially.

A. Note the height of the shower head. Decide if top trims will be installed above or below shower head/escutcheon, keeping in mind that trims can overlap panels from 1/2" to 2-1/2". Mark a level line at desired height of the top of the trim on the back wall (above the back wall panel).

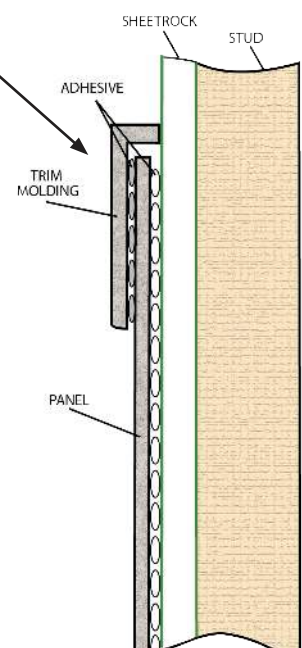
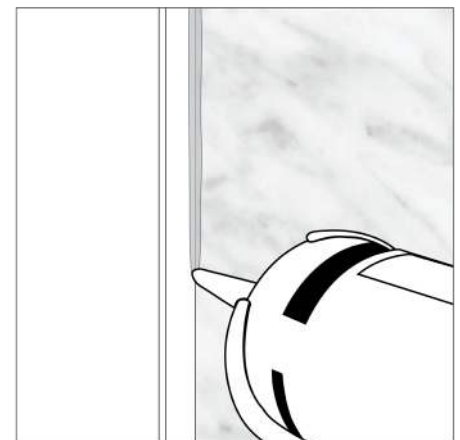
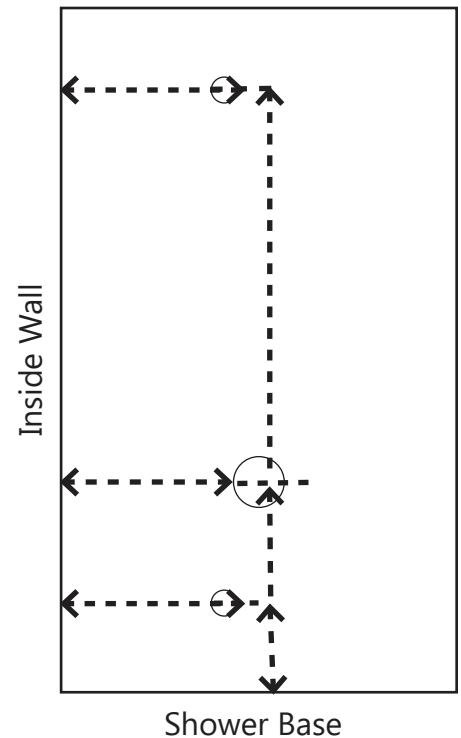

B. Place horizontal left wall top mitered trim (Item D) in place, push into the corner against back wall panel, then level it. Mark a level line on the wall on the top side of the trim molding near the outer end. Set aside this trim piece.

C. Measure from the floor to the level mark made in 4.B to determine the length needed for the vertical trim molding piece (Item C). Cut vertical trim molding piece (C) to this length, but do not cut from the pre-mitered end!

D. Fit vertical trim piece (C) over panel and plumb using a level. If contour cutting this trim molding to match the shower base shape, do so now. You can scribe the contour with a compass, or by hand, and cut with a jig saw or utility knife. Peel away protective masking from the trim, apply adhesive to the back of the trim molding, and adhere it over the wall panel. Secure the trim piece in place while the adhesive cures using paint-safe masking tape.

E. Measure horizontal distance from back wall panel to the tip of miter on the vertical molding. Cut horizontal top trim molding (Item D) to this dimension by cutting off the end opposite the miter. Be sure not to cut the mitered end.

F. Dry fit the trim molding D in place for a tight fit. Peel away protective masking from the trim, apply adhesive on the backside of the molding and adhere to the wall as before. Make any minor adjustments necessary to ensure that the mitered end makes a tight joint.

G. Repeat 4.B-4.F for the opposite wall trims (E, F).

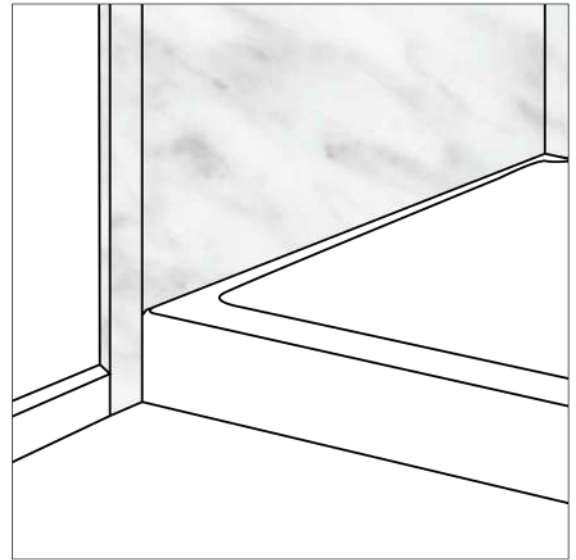

Vertical trims installed outside shower base

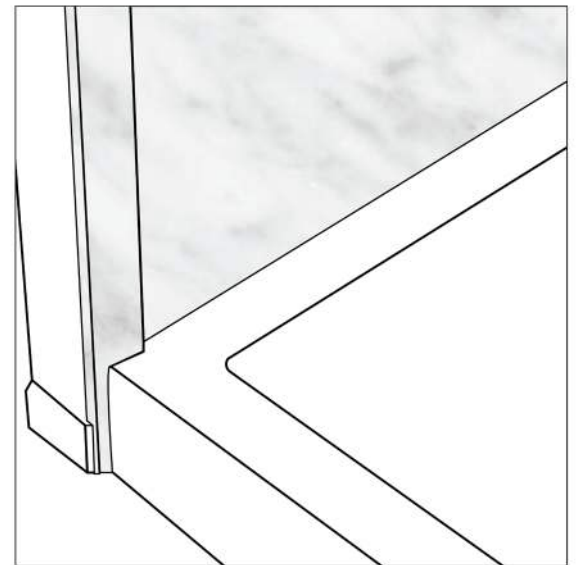

Vertical trims contour cut to overlap threshold



**FLEXSTONE WALL
PANELS ARE
1/4 IN. THICK.**

5. Installation of Corner Shelf (I)

NOTE: Corner shelf includes a folding-triangle metal bracket with screw holes which is designed to mount directly to the FlexStone wall panels. Be sure to peel away protective masking from the installation area before securing the bracket.

- A. Position corner shelf bracket in desired corner at desired height. Use a level to mark level lines in pencil. Adjust the alignment to include a slight forward slope for water runoff.
- B. Using drywall screws or other coarse-thread screws, fasten each side of the bracket through the FlexStone panels and the sheetrock.
- C. Fold bracket and complete triangle by bending the tab over to secure bracket. Dry fit the corner shelf material over the bracket. If corner is out of square, trim one side of shelf to achieve a tight fit.
- D. Peel back protective masking from edges of shelf, apply adhesive to top and bottom of bracket and place FlexStone material over bracket like a clamshell. Clamp until dry (24 hours).

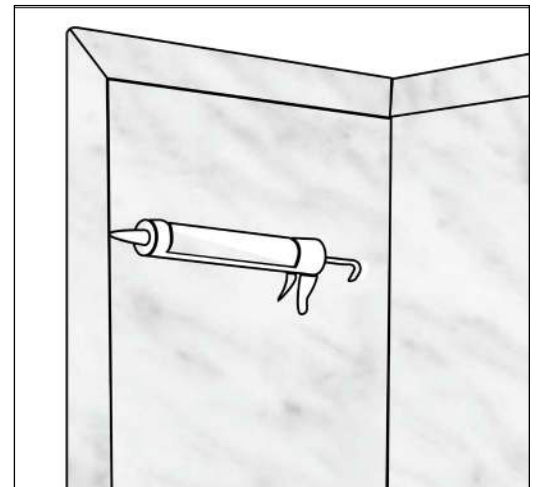
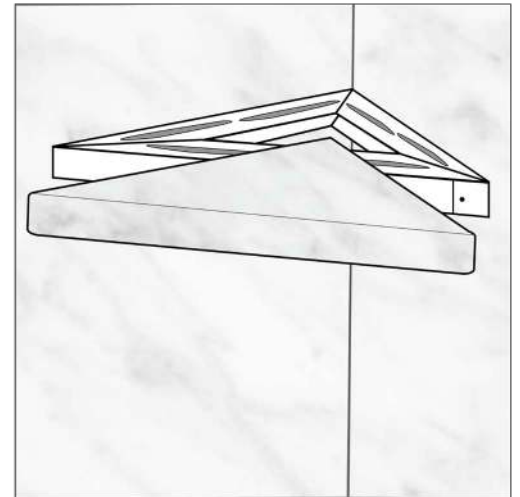
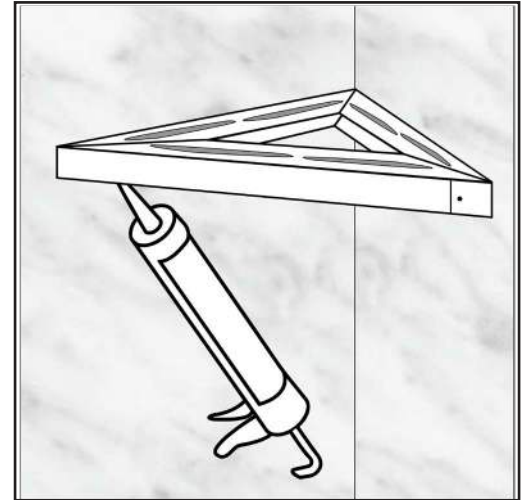
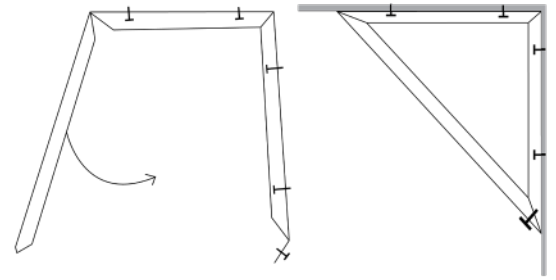

6. Sealing with Silicone

- A. If you desire to paint the walls now or in the future, use paintable latex caulk where trim moldings meet sheetrock. Use wet finger or caulk tool to shape the latex caulk to a nice finish.
- B. Using denatured alcohol, clean and prime all joints in the surround, including vertical and horizontal joints where panel meets tub, panel meets panel, or trim meets panel. Clean any oils, greases, or adhesive residues from these joints.
- C. Seal all joints in your surround with 100% silicone. Our installation kit has color-matched translucent silicone, tinted to complement your selected FlexStone color. Apply a fine bead of silicone to all joints. Use wet finger or caulk tool to shape the silicone to a nice finish. Follow any directions on sealant tube.



PLEASE WAIT 24 HOURS BEFORE INSTALLING FINISH PLUMBING OR USING YOUR NEW TUB/SHOWER SURROUND. REMOVE REMAINING PROTECTIVE MASKING PRIOR TO USE.